

# PARTS LIST



2019.01.07

# TABLE OF CONTENTS

---

Cabinet .....	1
Frame .....	3
Motor .....	5
Motor - suspension .....	7
Pump .....	9
Electric box .....	12
Default accessories .....	15
Hose reel .....	17
Recommended spare parts .....	19

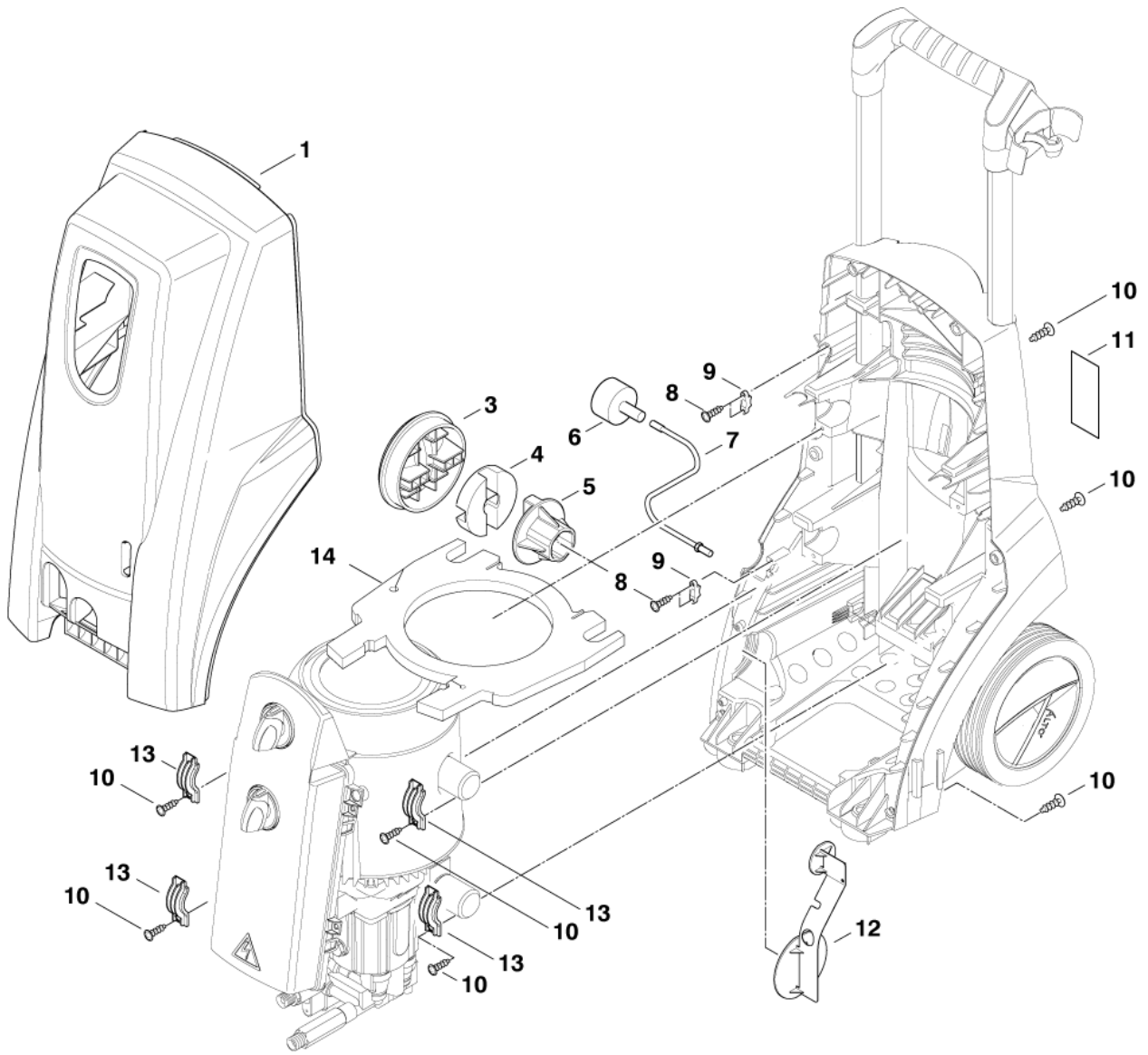

Pos.	Réf article	Qté	Désignation	Notes
00	101117819	1	KIT BOITIER POSEIDON 3-4	[1]
01	301002782	1	CAPOT POSEIDON 4	[2]
03	6528435	1	BOUTON MAINTIEN PRESSION	[3]
04	6528579	1	PIÈCE DE RACCORDEMENT	[3]
05	301002756	1	ACCOUPLLEMENT	[3]
06	6528559	1	MANOMÈTRE	[4]
07	301002777	1	TUBE	[5]
08	909100443	4	VIS K30X18T12 WN5452	
09	3806262	1	COLLIER POUR CÂBLES	
10	1814614	14	VIS K50 X 18	
11	48083	1	ETIQUETTE 40X60	[6]
12	301002793	1	COUVERCLE	[6]
13	301002296	4	BRIDE DE MAINTIEN DE SUSPENSION 25X66	
14	301003119	1	ELEMENT INSONORISANT	[6]

Part Notes:

- [1] - not shown  
STOCK COVERS GUARANTEE
- [2] - Standard  
STOCK COVERS GUARANTEE
- [3] - optional  
STOCK COVERS GUARANTEE
- [4] - optional
- [5] - optional  
ALTERNATIVE USE PN 107144028
- [6] - STOCK COVERS GUARANTEE

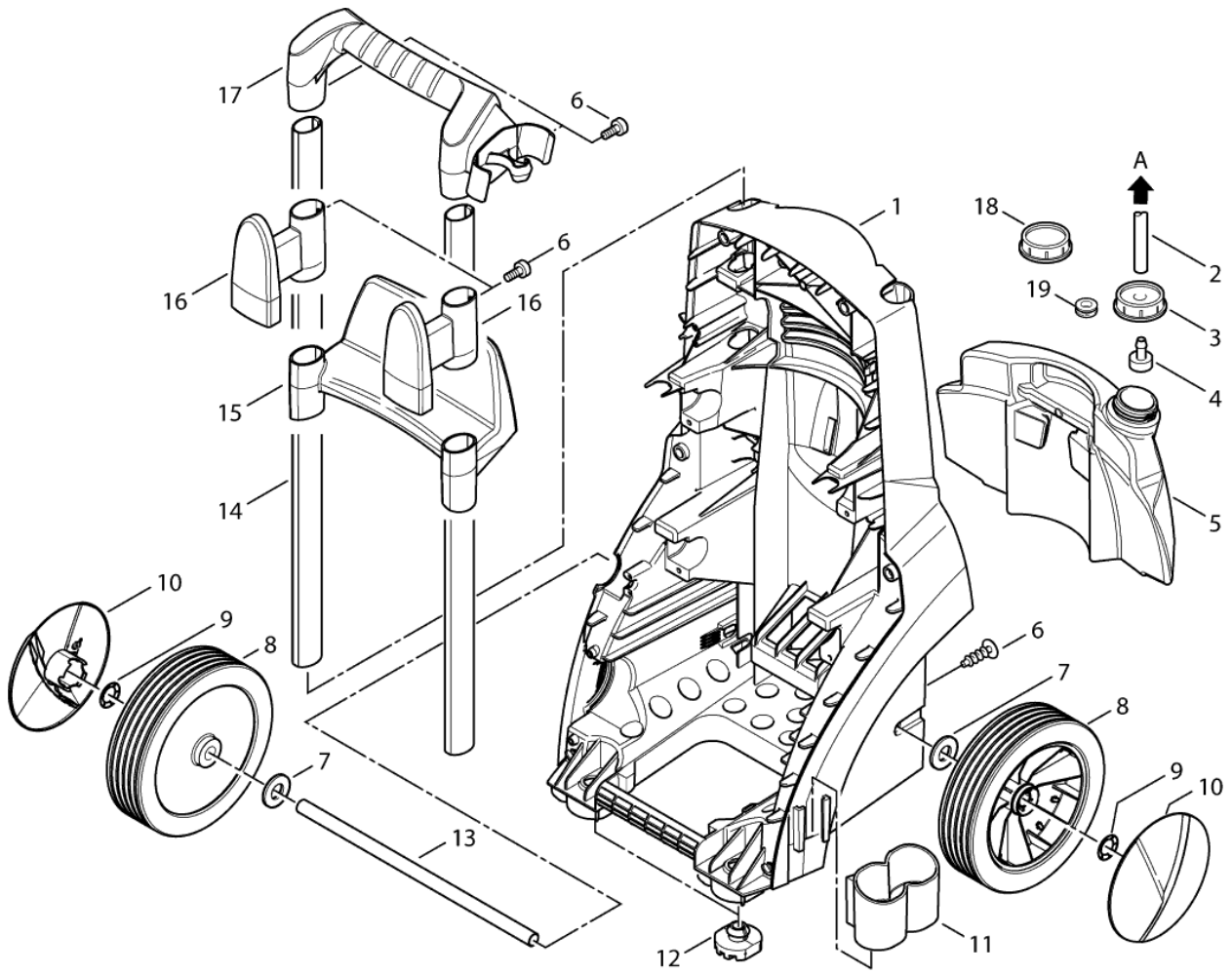

Pos.	Réf article	Qté	Désignation	Notes
1	301002740	1	CHÂSSIS	[1]
2	106408243	1	TUBE TRANSPARENT DE 5M 1/4INCH	
3	301001004	1	COUVERCLE	
3	107140889	1	CLOSING CAP WITH D10 HOLE	
4	6400240	1	CRÉPINE D'ASPIRATION	
5	301002751	1	RÉSERVOIR	
6	909100425	4	VIS M6X12 CE T30 DIN 7500 ST/ZN	
7	909100426	2	RONDELLE 16 17X30X30 DIN 34815 PA	
8	6528568	2	ROUE	[1]
9	11710	2	BAGUE D'ARRET Ø15 10PCS	
10	6522843	2	ENJOLIVEUR	[1]
11	301002300	1	FOURREAU	[1]
12	301002747	2	FOOT	[1]
13	301002304	1	AXE 15X1.5	
14	301002785	2	PROFIL D25X35	[1]
15	301002788	1	HOOK FOR HOSE PP	[2]
16	301002745	2	SUPPORT	[1]
17	301002290	1	MONTURE DE POIGNÉE	
18	106408247	1	BOUCHON DE RESERVOIR DETERGENT Ø65X20.5	
19	101117749	1	CABLE GROMMET	

Part Notes:

- [1] - STOCK COVERS GUARANTEE
- [2] - Standard  
STOCK COVERS GUARANTEE

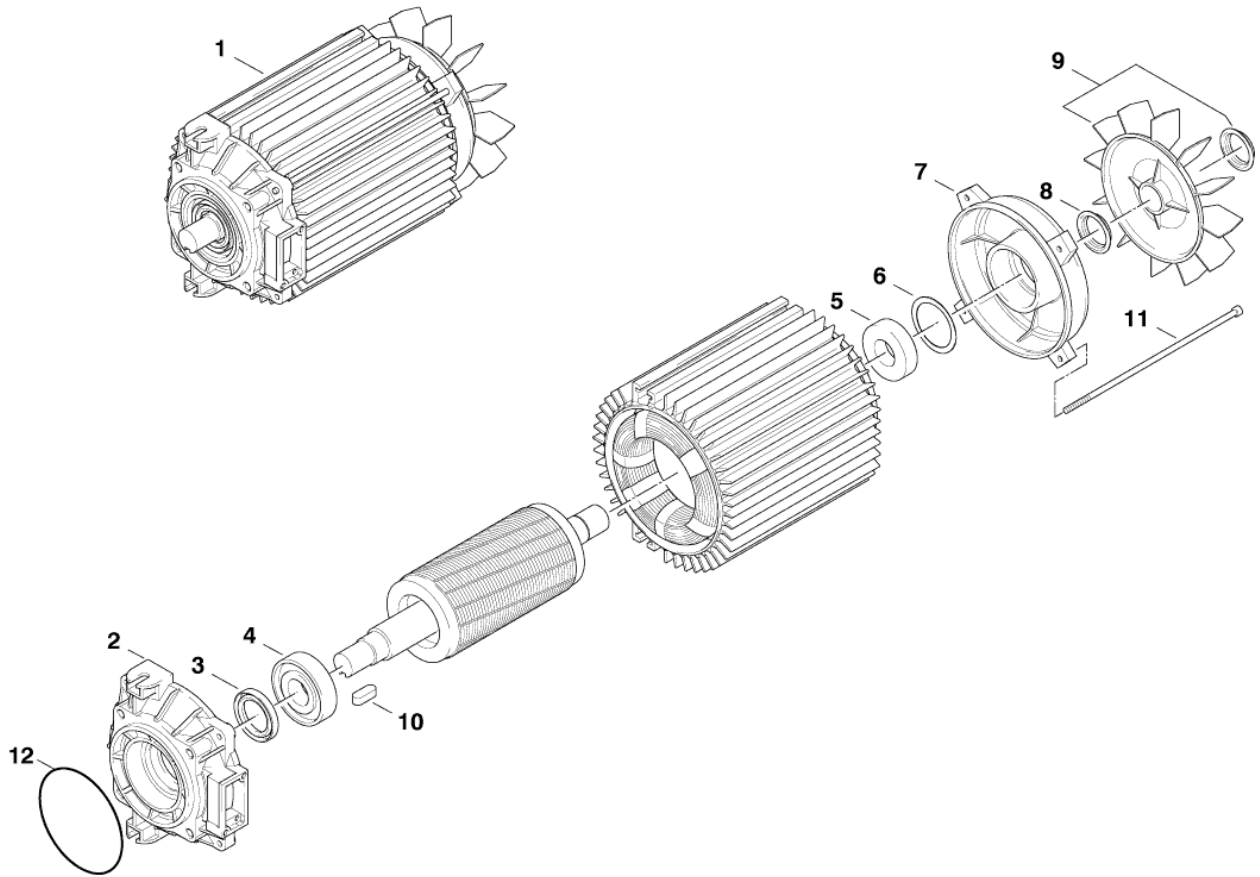

Pos.	Réf article	Qté	Désignation	Notes
1	101118024	1	MOTOR 5.2KW 200/346 3PH	[1]
1	107145035	1	MOTOR 2.2kW/230V/50Hz/1pH	[2]
1	107145036	1	MOTEUR 2.8kW/220-230/400V/50-60Hz	[2]
1	301003123	1	MOTOR 200V 60HZ	[3]
1	107145036	1	MOTEUR 2.8kW/220-230/400V/50-60Hz	[3]
1	107145035	1	MOTOR 2.2kW/230V/50Hz/1pH	[3]
2	301003077	1	CARTER DE COMMANDE	
3	301003078	1	JOINT D'HUILE	
4	301003079	1	ROULEMENT 7305	
5	301003080	1	ROULEMENT 6205ZZ HELICE DE VENTIL.	
6	301003081	1	O RING DIA 52	
7	107145037	1	FLASQUE ARRIERE MOTEUR	[2]
7	301003082	1	BEARING COVER	[3]
8	103004397	1	ANNEAU DE JOINT	
9	107145038	1	HELICE VENTILATION AVEC CLIPS	[2]
9	301003084	1	VENTILATEUR	[3]
10	101814798	1	CLAVETTE 6 X 6 X 20 MM	
11	301003085	4	SCREW M5X205	
12	61026	1	JOINT TORIQUE 94.92X2.62	

## Part Notes:

- [1] - STOCK COVERS GUARANTEE
- [2] - - RF – has Nilfisk letter on the motor type plate
- [3] - - EME – has EME letter on the motor type plate



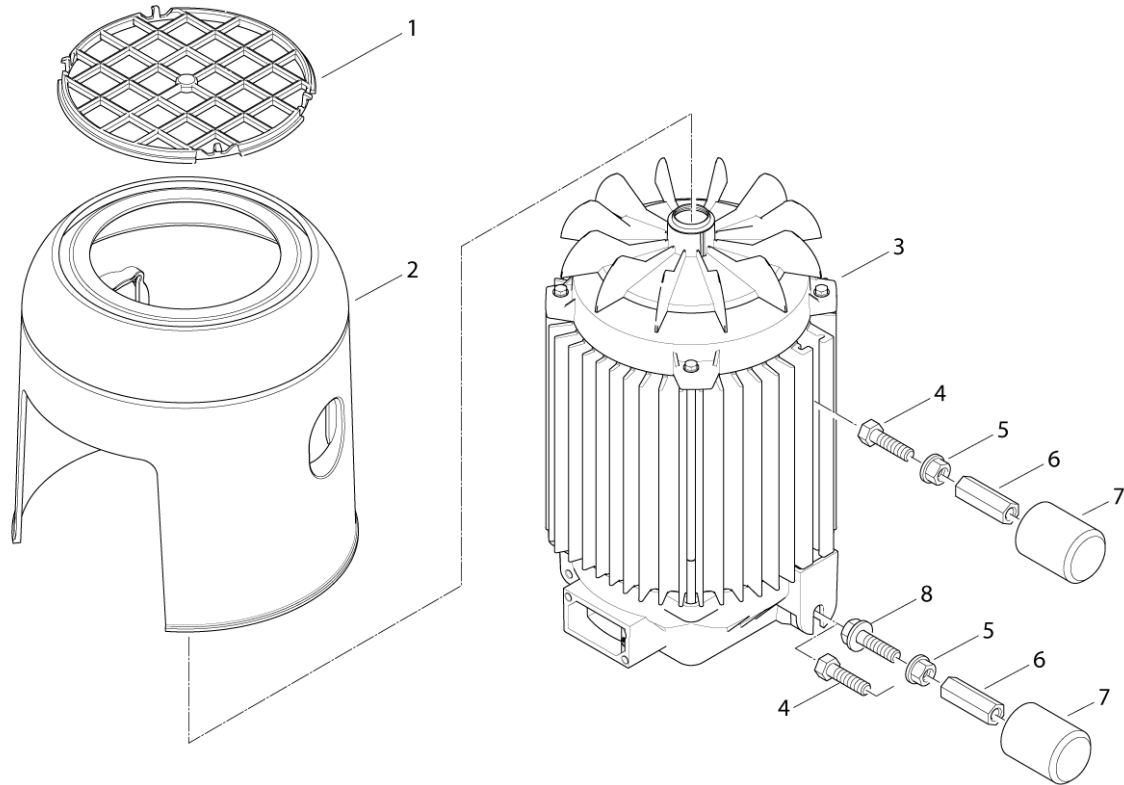

Pos.	Réf article	Qté	Désignation	Notes
0	301003119	1	ELEMENT INSONORISANT	[1]
01	301002778	1	GRID FANCAP	[1]
02	301002299	1	BAGUE DE VENTILATEUR	[1]
03	107145035	1	MOTOR 2.2kW/230V/50Hz/1pH	[2]
03	107145036	1	MOTEUR 2.8kW/220-230/400V/50-60Hz	[2]
03	301003123		MOTOR 200V 60HZ	[3]
03	107145035	1	MOTOR 2.2kW/230V/50Hz/1pH	[3]
03	107145036	1	MOTEUR 2.8kW/220-230/400V/50-60Hz	[3]
04	2753	4	VIS M8X20 ISO 4017 ZN	[4]
05	61467	4	ECROU HEX M8	
06	301002303	4	BOULON	[1]
07	301002298	4	BUTOIR	[1]
08	27372	2	VIS M8X20	[5]

## Part Notes:

- [1] - STOCK COVERS GUARANTEE
- [2] - - RF – has Nilfisk letter on the motor type plate
- [3] - EME – has EME letter on the motor type plate
- [4] - (4 pcs. RF) - (2 pcs. EME)
- [5] - Only EME



Pos.	Réf article	Qté	Désignation	Notes
0-	909100414	1	HUILE ROTRA THT 1L	[1]
1	301003031	1	PISTON DISTRIBUTEUR	
2	301003032	1	JEU DE JOINTS	
3	301003033	1	BAGUE DE LOGEMENT DE SOUPAPE	
4	301003034	1	RONDELLE 6,75X1,78	
5	301003035	1	VIS M6	
6	301003036	1	SOUPAPE	[2]
7	301003037	1	JEU DE JOINTS	[2]
8	301003038	1	SIÈGE DE POINTEAU DE SOUPAPE	[2]
9	301003039	3	BOUCHON D 156	
9A	301003071	1	BOUCHON	
10	301003040	3	JOINT D 15.6 X 1.78	
11	107145272	1	JEU DE SOUPAPES	
12	301003042	1	JEU DE JOINTS DE PISTONS	
13	301003043	1	JOINT TORIQUE D.10,82X1,78	
14	301003044	1	BOUCHON FILETE	
15	301003045	1	BLOC DE SOUPAPES	
16	301003046	1	BOUCHON FILETÉ	
17	301003047	1	SUPPORT	
18	301003048	1	VIS M5X10	
19	301003049	3	VIS M 12X70MM	
20	301003050	3	RONDELLE D.12	
21	301003051	1	PISTON DISTRIBUTEUR	
22	301003052	1	PIÈCE DE RACCORDEMENT	
23	301003053	1	ETRIER	
24	301003054	1	INTERRUPTEUR	
25	301003055	1	SOUPAPE ANTIRETOUR	
26	301003056	1	JEU DE JOINTS	
27	301003057	1	INJECTEUR	
28	301001559	3	DOUILLE Ø18 NP3- HP	
29	301003059	3	GUIDE-PISTON	
30	301003060	1	TUYAU	
31	301003061	2	COLLIER DE SERRAGE	
32	301003062	2	RACCORD DE FLEXIBLE	
33	301003063	4	VIS M5X25	
35	301003064	1	BOUCHON FILETÉ	
36	301003065	1	CARTER DE POMPE	
37	301003066	1	JEU DE PISTONS	
38	301003067	1	ROULEMENT À AIGUILLES	
39	301003137	1	DISQUE EN NUTATION 11°	[3]
39	301003140	1	DISQUE EN NUTATION 9°	[4]
39	301003139	1	DISQUE EN NUTATION 13°	[5]
39	301003138	1	DISQUE OBLIQUE 11°30'	[6]
40	301003070	1	RACCORD POUR TUYAU FLEXIBLE	
40A	301003159	1	KIT CLAPET D ASPIRATION	
41	301003071	1	BOUCHON	[7]
41	107140195	1	ACCOUPLLEMENT	[8]
41	301002757	1	ACCOUPLLEMENT	[9]
42	301003072	1	TAMIS	
43	301003073	1	BOUCHON FILETÉ	[10]
43A	301003160	1	KIT JOINTS TORIQUES	
44	106404529	1	RACCORD GARDENA MALE 3/4"	
45	106408169	1	RACCORD SORTIE DE POMPE G3/8	[11]
46	101117994	1	CIRCLIPS D.23 DIN471	
47	31000344	1	JEU DE JOINTS	
XX	301002752	1	RACCORD	

## Part Notes:

- [1] - 0,225 l - OIL TYPES\_QUANTITY for HPW\_APRIL 2017
- [2] - 1~
- [3] - EU 1ph and 3x200V,60Hz (JP)
- [4] - \*GB,3 ph\* - 1/220V/60HZ
- [5] - EU 3ph and 3x200V,50Hz (JP)
- [6] - \*GB,1ph\*
- [7] - up to 12.2007
- [8] - from 01.2008
- [9] - from 01.2008 pos. 41, 42, 44  
STOCK COVERS GUARANTEE
- [10] - 3~
- [11] - For machines without hose reel

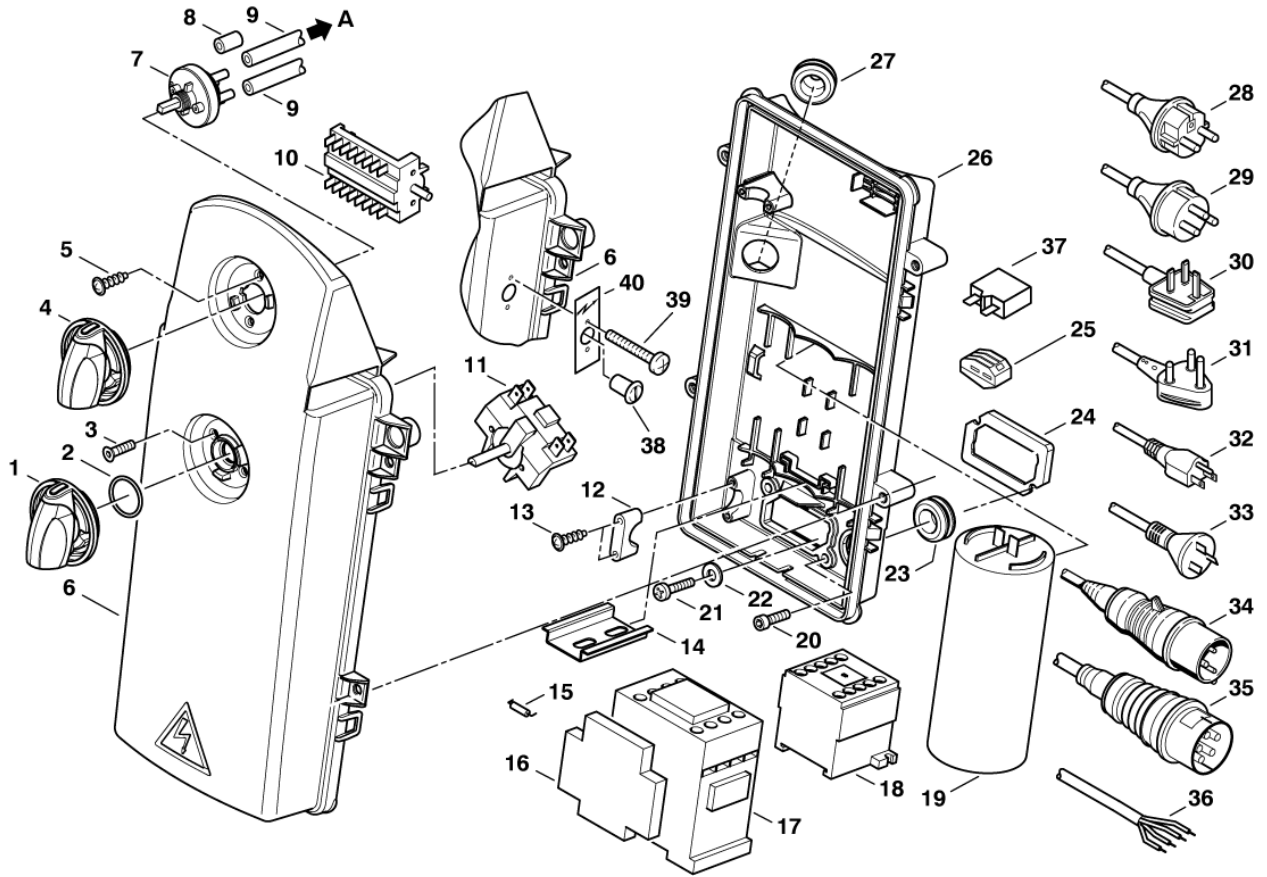

Pos.	Réf article	Qté	Désignation	Notes
1	909100204	1	BOUTON TOURNANT 6X5 BLUE	
2	9868	1	JOINT TORIQUE 10.2X2.5 NBR 70	
3	18274	2	VIS TETE FRAISEE M4X12	
4	909100214	1	BOUTON TOURNANT BLEU	
5	1814730	2	VIS	
6	107140886	1	COUVERCLE DE BOITIER ELECTRIQUE	[1]
6	107140885	1	KIT COUVERCLE BOITIER INTERRUPTEUR	[2]
7	301001000	1	VANNE DETERGENT	
8	301001906	2	CAPUCHON	
9	106408243	1	TUBE TRANSPARENT DE 5M 1/4INCH	
10	64579	1	COMMUTATEUR Y/16A	[3]
11	301001058	1	INTERRUPTEUR 0-1 10A 400VAC	
12	3806262	1	COLLIER POUR CÂBLES	
13	909100443	2	VIS K30X18T12 WN5452	
14	22290	1	PROFILÉ SUPPORT 1 M	[4]
15	301000074	1	RESISTANCE 470 OHM 3W	[5]
16	64773	1	CONTACT AUXILIAIRE 100-SBL11	[6]
16	101118041	1	ANDELI LA8-DN11 SIDE MOUNT AUX CONTACT	[7]
17	63905	1	CONTACTEUR ÉLECTROMAGNÉTIQUE 3X200/230 V	[6]
18	103822303	1	CONTACTEUR CJX2-D18 18A 400V 3P+NO	[8]
19	301002798	1	CONDENSATEUR 80 µF	[9]
20	909100424	2	SCREW M5X16 CE T25 DIN 7500 ST/ZN	
21	909100423	1	SCREW M4X 6 CE T20 DIN 7500 ST/ZN	[10]
22	4021	1	RONDELLE EVANTAIL	
23	3803772	1	CABLE PASSE FILS TET 7-10C	
24	301002283	1	JOINT	[10]
25	301001229	1	CONNECTEUR GRIP GRIS 3X4QMM 400V 24A	
26	301002281	1	BOITE INFERIEURE ELECTRIQUE	
27	301002284	1	PASSE FIL	
28	7180226	1	CÂBLE D'ALIMENTATION EUROPA	[11]
30	7180225	1	POWER CORD RN-F 3G1.5X6	[12]
31	301002337	1	POWER CORD RN-F 3G1.5X6M SABS 164	[13]
32	3821649	1	POWER CORD SJTW AWG14/3X11M	[14]
33	3821142	1	POWER CORD SJTAWWG 12/3X11	[14]
33	301002336	1	POWER CORD RN-F 3G1.0X6M AS3112	[15]
34	7180232	1	ELEC. CABLE. 110V 50HZ GB	[16]
35	63499	1	POWER CORD H07RN-F 4G1.5X6M	[17]
36	63501	1	POWER CORD H07RN-F 4G1.5X6M	[18]
37	301002659	1	FUSIBLE 20A TYPE 1658	
37	301002324	1	FUSIBLE 12 A	[10]
37	301002322	1	PROTECTION 16AMPS TYPE 1658	
38	64580	1	BOUTON TOURNANT	[19]
39	3389	2	VIS M4X20 ISO 1207 ZN	[5]
40	64586	1	AUTOCOLLANT	[20]
40	64787	1	LABEL 220-440V CHANGE-OVER 74X28	[21]

Part Notes:

- [1] - 4-36 NO, EXPT, see note:  
STOCK COVERS GUARANTEE
- [2] - STOCK COVERS GUARANTEE
- 4-28, 4-29, 4-30, 4-35 JP
- [3] - \* SEE NOTE
- [4] - \*\* SEE NOTE
- [5] - \* NOTE: 230/400/3/50 \*BE\*NO\*, 220/440/3/60 \*EXP\*
- [6] - NOTE: 230/400/3/50 \*BE\*NO\*, 220/440/3/60 \*EXP\*
- [7] - ANDELI  
STOCK COVERS GUARANTEE
- [8] - 400/3
- [9] - 230V \*EU\*, 220V \*EXP\*

- 
- [10] - STOCK COVERS GUARANTEE
  - [11] - \*EU\*EXP\*  
STOCK COVERS GUARANTEE
  - [12] - \*GB\*  
STOCK COVERS GUARANTEE
  - [13] - \*ZA\*  
STOCK COVERS GUARANTEE
  - [14] - \*US\*  
STOCK COVERS GUARANTEE
  - [15] - \*AU\*  
STOCK COVERS GUARANTEE
  - [16] - NO LONGER AVAILABLE
  - [17] - \*EU\* 400/3/50  
STOCK COVERS GUARANTEE
  - [18] - 230/400/3/50 \*BE\*NO\*, 220/440/3/60 \*EXP\*, JP  
STOCK COVERS GUARANTEE
  - [19] - NOTE: 230/400/3/50 \*BE\*NO\*, 220/440/3/60 \*EXP\*

TSB-PPW-2016-007 Rotary knob for Voltage selector switch 230V-400V must be sealed with lacquer

DE TSB-PPW-2016-007 Drehknopf des Spannungsauswahlschalters 230V-400V muss mit Lack versiegelt werden

- [20] - 230/400/3/50 \*BE\*NO\*
- [21] - 220/440/3/60 \*EXP\*  
STOCK COVERS GUARANTEE





Pos.	Réf article	Qté	Désignation	Notes
0-	106403122	1	PISTOLET ERGO 2000 STANDARD	
00	101119736	1	BUSE TORNADO PLUS 0350	[1]
00	101119740	1	BUSE TORNADO PLUS 0450	[2]
00	106402281	1	LANCE FLEXOPOWER PLUS COURBEE L99	
00	101119738	1	BUSE TORNADO PLUS 0400	[3]
00	101119746	1	BUSE TORNADO PLUS 0650	[4]
01	301002275	1	FLEXIBLE HP 10M DN6 2X3/8M+ERGO FEMELLE	[5]
01	6101767	1	FLEXIBLE HP 10M DN10 2X3/8M ANTI TRACE	
02	1401983	1	FLEXIBLE HP 15M DN10 2X3/8M ANTI TRACE	
02	101406176	1	FLEXIBLE HP 15M DN6 1X3/8M POUR ENROULEU	[6]
03	301002701	1	ENROULEUR	[7]
04	301002411	1	POIGNEE ERGO 1000 VARIO P	[8]
05	106408240	1	LANCE POUR 4-IN-1 880 BEND	

## Part Notes:

- [1] - 4-29, 2-29 XT, 4-30, 4-30 XT
- [2] - 4-35, 4-36, 4-36 XT
- [3] - 4-28, 4-28 XT
- [4] - 4-31
- [5] - 4-28, 4-31, 4-36
- [6] - 4-28 XT, 4-29 XT, 4-30 XT, 4-36 XT
- [7] - X-tra
- [8] - Up to 2010  
REPLACED

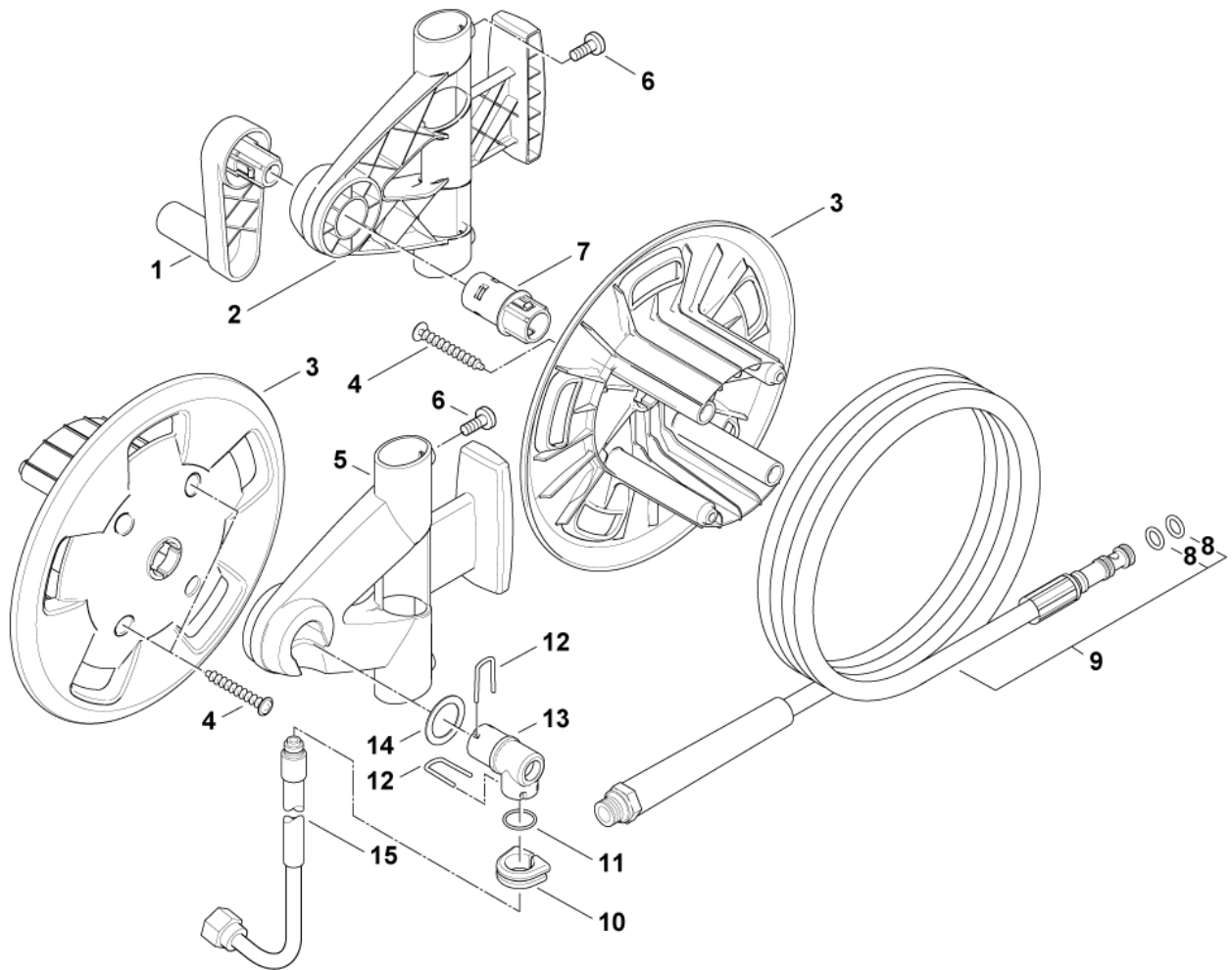

Pos.	Réf article	Qté	Désignation	Notes
0-	301002701	1	ENROULEUR	
01	6528569	1	MANIVELLE	
02	301002274	1	SUPPORT	
03	6528570	2	TAMBOUR D'ENROULEMENT	
04	1814614	4	VIS K50 X 18	
05	301002272	1	SUPPORT	
06	909100425	4	VIS M6X12 CE T30 DIN 7500 ST/ZN	
07	301002273	1	ACCOUPLLEMENT	
08	3004321	2	JOINT TORIQUE 10X2	
09	101406176	1	FLEXIBLE HP 15M DN6 1X3/8M POUR ENROULEU	
10	301002746	1	DOUILLE	
11	3002144	1	JOINT TORIQUE 14.3X2.4	
12	6526487	2	ETRIER	
13	6127990	1	RACCORD	
14	6127995	1	RONDELLE	
15	301002795	1	FLEXIBLE HAUTE PRESSION DN 8, 794 MM	



Pos.	Réf article	Qté	Désignation	Notes
0A	301002659	1	FUSIBLE 20A TYPE 1658	[1]
0A	301003042	1	JEU DE JOINTS DE PISTONS	[1]
0A	301003072	1	TAMIS	[1]
0A	301002322	1	PROTECTION 16AMPS TYPE 1658	[1]
0A	31000344	1	JEU DE JOINTS	[1]
0A	107145272	1	JEU DE SOUPAPES	[1]
0A	301002324	1	FUSIBLE 12 A	[2]
0B	301003037	1	JEU DE JOINTS	[3]
0B	301003055	1	SOUPAPE ANTIRETOUR	[3]
0B	301003032	1	JEU DE JOINTS	[3]
0B	301003036	1	SOUPAPE	[3]
0B	301003031	1	PISTON DISTRIBUTEUR	[3]
0B	301003038	1	SIÈGE DE POINTEAU DE SOUPAPE	[3]
0C	301003054	1	INTERRUPTEUR	[4]
0C	103822304	1	CONTACTEUR CJX2-D18 18A 230V 3P+NO	[4]
0C	301003067	1	ROULEMENT À AIGUILLES	[4]
0C	301003080	1	ROULEMENT 6205ZZ HELICE DE VENTIL.	[4]
0C	301003123	1	MOTOR 200V 60HZ	[4]
0C	301002795	1	FLEXIBLE HAUTE PRESSION DN 8, 794 MM	[4]
0C	64579	1	COMMUTATEUR Y/16A	[4]
0C	107145036	1	MOTEUR 2.8kW/220-230/400V/50-60Hz	[4]
0C	64773	1	CONTACT AUXILIAIRE 100-SBL11	[4]
0C	301003137	1	DISQUE EN NUTATION 11°	[4]
0C	301003138	1	DISQUE OBLIQUE 11°30'	[4]
0C	301003066	1	JEU DE PISTONS	[4]
0C	107145035	1	MOTOR 2.2kW/230V/50Hz/1pH	[4]
0C	301003079	1	ROULEMENT 7305	[4]
0C	103822303	1	CONTACTEUR CJX2-D18 18A 400V 3P+NO	[4]
0C	101118041	1	ANDELI LA8-DN11 SIDE MOUNT AUX CONTACT	[5]
0C	301003140	1	DISQUE EN NUTATION 9°	[4]
0C	301002798	1	CONDENSATEUR 80 µF	[4]
0C	301001058	1	INTERRUPTEUR 0-1 10A 400VAC	[4]
0C	301003139	1	DISQUE EN NUTATION 13°	[4]

## Part Notes:

- [1] - A  
 [2] - A  
 STOCK COVERS GUARANTEE  
 [3] - B  
 [4] - C  
 [5] - C  
 STOCK COVERS GUARANTEE

